

Individual Shingles Installation Guide

Read this entire guide before installing Maibec individual shingles. For proper installation, you must understand and follow all requirements and steps correctly. For any questions, please contact Maibec's technical service toll-free at 1 800 363-1930, Monday to Friday from 8:30 a.m. to 4:30 p.m. (Eastern Time).

IMPORTANT: COMPLIANCE WITH MAIBEC'S INSTALLATION, STORAGE AND MAINTENANCE REQUIREMENTS, AND WITH ALL APPLICABLE BUILDING CODES IS MANDATORY. PROBLEMS CAUSED BY FAILURE TO COMPLY WITH THESE REQUIREMENTS AND CODES MAY NOT BE COVERED BY THE APPLICABLE WARRANTIES.

Factory-stained white cedar individual shingles can only be installed to exterior wall surfaces.

Shingles have one side that is smoother and more uniform than the other. Be sure to install them with this side facing outward.

All dimensions in this document are given in inches.

1. STORAGE

- Store the shingle siding in an unheated, dry and ventilated area.
- Leave shingle boxes on pallet. Do not store the material in direct contact with the ground or a cement floor.
- Always cover the uninstalled material after a day's work.

2. BEFORE YOU BEGIN INSTALLATION

CHECK YOUR ORDER

- Make sure the product(s) delivered matches your order (colour, quantity etc.).
- Have touch-up stain on hand.
- Never install a product that appears to be or that you think may be defective. Installed defective products are not covered by the warranty. Contact Maibec at 1 800 363-1930.

CONSULT THE BUILDING CODES

Make sure you are familiar with the specific requirements of all applicable federal and provincial building codes and municipal by-laws for your region. For more information, see the National Model Construction Codes on the Government of Canada's website at nationalcodes.nrcc.gc.ca.

3. CUTTING SHINGLES

Since cedar is a soft wood, shingles can be easily cut with a utility knife. Cutting a shingle lengthwise is simple: make a straight cut into its surface, then snap the shingle cleanly along the scored line or use a power saw.

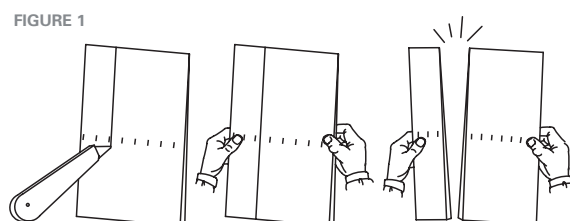

4. TOUCH-UP STAIN

Apply touch-up stain on all cuts, planed edges, and small damaged areas. All bare wood must be touched-up, regardless of whether it is visible or not once installed. Touch-up on cuts must be performed prior to shingle installation.

For shingle touch-ups, use the Maibec touch-up applicator. For shingle touch-ups when using touch-up stain in a can, use a polyester, nylon, or any synthetic applicator with firm bristles approved for water-based coatings. Do not use wide brushes that could cause drips and give poor results. Carefully dab, do not spillover or overbrush.

Touch-up stain is only meant to be used in the area in need of it. It must not, under any circumstance, be applied over non-damaged factory coated material.

For more information, see the touch-up guide that comes with the touch-up stain cans or kits, or go to maibec.com/en/support.

FIGURE 2

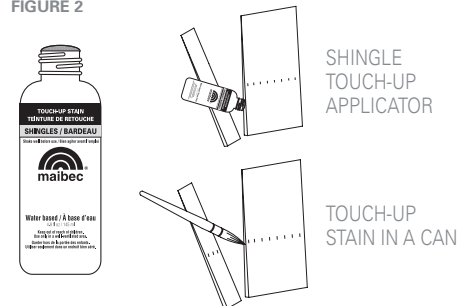

5. DETERMINING EXPOSURE

The exposure is the part of the shingle that you see. **The exposure for shingles is 5"** but can vary between 1/8" to 1/4" depending on the height of the wall and the window positions.

To determine the number of courses needed and the exposure, measure the height of the wall from its lowest point (above the foundations). The butt edge of the first course of shingles must extend at least 1" beyond the foundation, so add 1" to the height of the wall. To determine the number of courses, divide the height of the wall by the exposure (5"). Then calculate back by dividing the height of the wall by the number of courses previously obtained (rounded off) to determine the exact exposure.

Use a wooden pole that is long enough to measure the exposure over several courses. A straight furring strip should do the job. Once marked, place the pole against the wall to check the alignment of the courses with the windows. If possible, the shingle courses should be aligned with window tops and bottoms, or the exposure should be at least 4" in these areas. The last course at the top of the wall should also have at least 4" of exposure. If not, recalculate to get enough exposure, then mark the pole once again. Using the pole, mark the exposure lines on the wall. Keep the pole as a reference while installing the shingles.

FIGURE 3

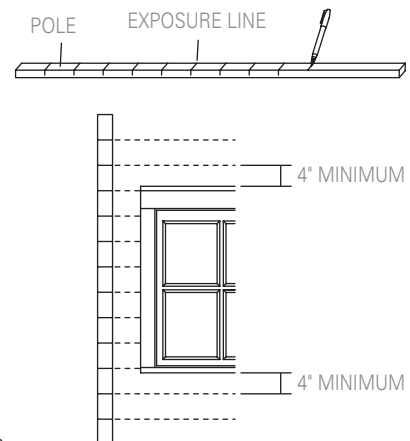

6. FASTENERS

THE FASTENING REFERENCE LINE

Shingle fastening is simpler with this easily identifiable guide. The reference line is found 6 1/4" from the base of the shingle. For the 5" required shingle exposure, fasten just below the reference line to respect the installation requirement. Each individual shingle is marked on one side.

NAILS:

- stainless steel or hot dipped galvanized
- ring shank blunt tip nail with minimum 7/32" head or

STAPLES:

- stainless steel or aluminum staple with minimum 7/16" crown, minimum 16 gauge.

FIGURE 4

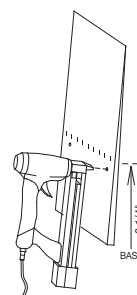
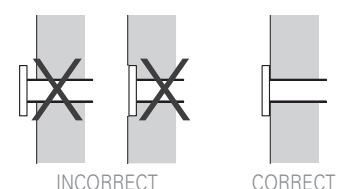

FIGURE 5



Two fasteners per shingle, regardless of its width. Located 3/4" from each edge and 1" above the butt line of the overlapping shingle. Must penetrate solid nailable substrate minimum 1/2" (example: plywood).

IMPORTANT: COMPLIANCE WITH MAIBEC'S INSTALLATION, STORAGE AND MAINTENANCE REQUIREMENTS, AND WITH ALL APPLICABLE BUILDING CODES IS MANDATORY. PROBLEMS CAUSED BY FAILURE TO COMPLY WITH THESE REQUIREMENTS AND CODES MAY NOT BE COVERED BY THE APPLICABLE WARRANTIES.

7. EXPOSURE AND KEYWAY SPACING

The exposure for shingles is 5".

Leave a keyway space of at least 1/8" between shingles. The edges should not touch. The keyway spacings on consecutive rows must be offset a minimum 1 1/2".

FIGURE 6

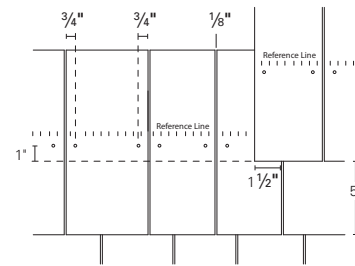

8. THE STARTER COURSE

The starter course has two layers of shingles. The easiest method consists of installing 2 courses of full-length shingles one on top of the other, making sure that joints aren't aligned over subsequent courses. [FIGURE 7]

Another method consists of installing the first course using shingles trimmed 5" from the base, then continuing the second course with full-length shingles, making sure that joints aren't aligned over subsequent courses. With this method, all the courses will have the same thickness on the wall. [FIGURE 8]

FIGURE 7

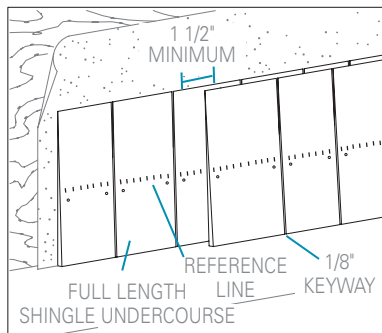
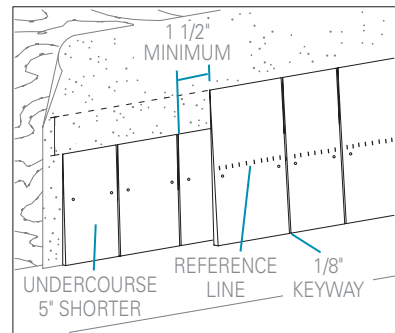

FIGURE 8



The starter course must extend at least 1" beyond the foundation to keep water off the wall. The second course extends slightly below (1/2") the starter course to allow water to drip at the base of the shingles by gravity. [FIGURE 9]

The butt line of the starter course must have a minimum clearance of 8" (203 mm) with the ground surrounding the building.

ALLOW A MINIMUM CLEARANCE OF:

- 2" from adjacent horizontal structures (example: deck),
- 2" from roof shingles or according to building code.

FIGURE 9

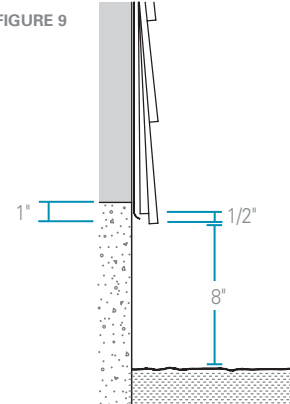

9. SUBSEQUENT COURSES

Shingles come in random widths, so you must make sure that the joints are not aligned over subsequent courses. Leave a keyway spacing of at least 1 1/2" from the shingles in the previous course. Ideally, no joints should be aligned over three subsequent courses. No joint should occur over a knot. [FIGURE 10]

Install subsequent courses in a single layer on the rest of the wall according to the determined exposure. Keep your courses straight and level. To make shingle alignment easier, tack a furring strip beneath the exposure line or make a chalk line. [FIGURE 11]

FIGURE 10

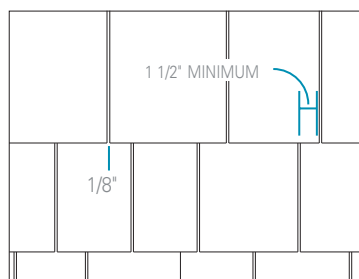
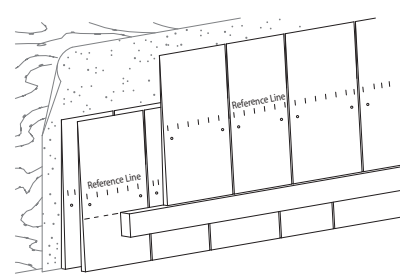

FIGURE 11



IMPORTANT: COMPLIANCE WITH MAIBEC'S INSTALLATION, STORAGE AND MAINTENANCE REQUIREMENTS, AND WITH ALL APPLICABLE BUILDING CODES IS MANDATORY. PROBLEMS CAUSED BY FAILURE TO COMPLY WITH THESE REQUIREMENTS AND CODES MAY NOT BE COVERED BY THE APPLICABLE WARRANTIES.

10. CORNERS FINISH DETAILS

THE BOSTON CORNER

The most common and traditional outside corner trim is made by overlapping shingles so that the joints alternate successively on each side of the corner. Nail the lower corner of the shingle with a ring shank blunt tip nail. [FIGURE 12]

- Choose a corner shingle that is wide enough to extend beyond the wall. Trim excess cleanly with a utility knife. You can trim it in place using the corner of the wall as a guideline, but for greater precision, you can mark a pencil line on the back of the shingle and cut it flat. [FIGURE 13]
- Tack the shingle in place while you install a second shingle that also extends beyond the wall on the other side. Trim the shingle, using the first shingle as a guideline. For a smooth finish, use a plane. [FIGURE 14]
- Apply touch-up stain to the cut edges, then nail the shingles in place according to the nailing recommendations. [FIGURE 15]

FIGURE 12

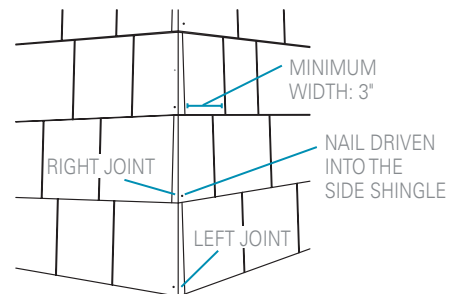

FIGURE 13

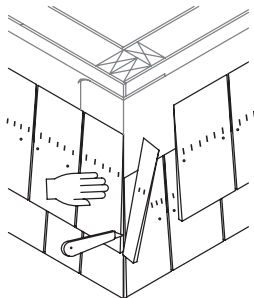

FIGURE 14

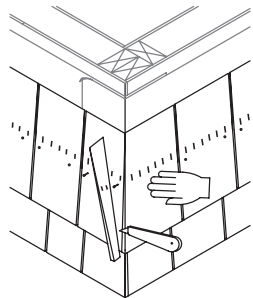
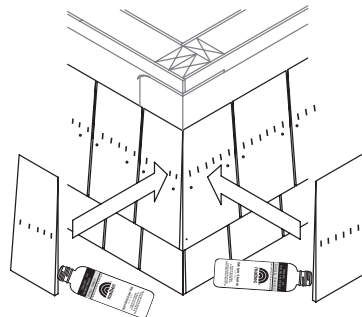

FIGURE 15



Maibec offers a pre-assembled Woven Corner. See the Maibec Woven Corner Installation Guide at maibec.com/en/support.

11. WINDOW FINISH DETAILS

WOOD CASED TRIM

FIGURE 16

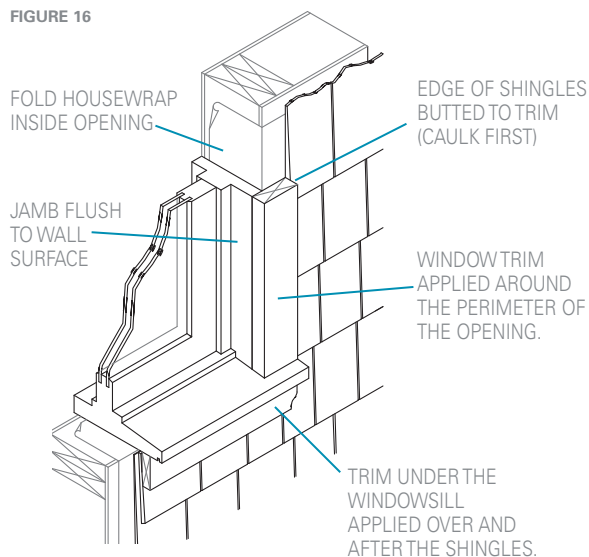

PERIMETER WOOD TRIM

FIGURE 17

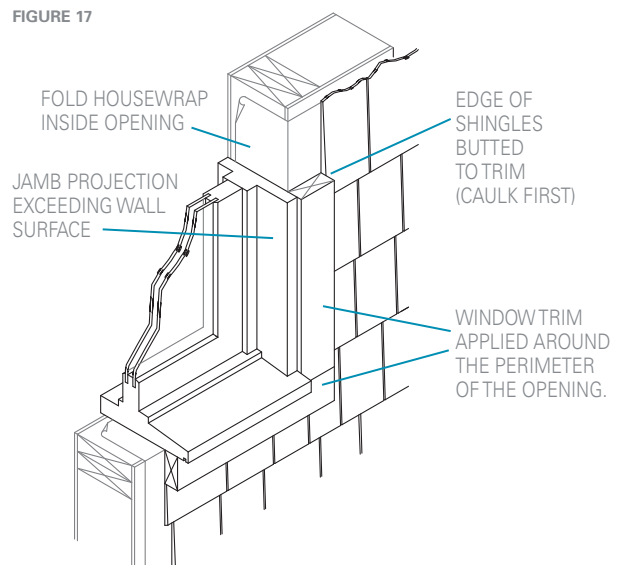

11. Window Finish Details (cont'd)

When a shingle is installed against the lower corner of the window opening, the joint must be aligned with the edge of the opening. For greater stability of shingles below openings, apply glue to the back and nail the bottom corners. Pre-drilling of the shingles may be required. [FIGURE 18]

THE WINDOW HEADER

The window header is a crucial element where water could accumulate and seep behind shingles, which could affect the structural integrity of the window frame. [FIGURE 19]

Metal flashing is essential to keep moisture away from the window header. The flashing should extend beyond the trim that will be installed. [FIGURE 20]

Shingles installed above window and door headers must be spaced 1/4" to 1/2" to ensure proper drainage and airflow. [FIGURE 21]

FIGURE 18

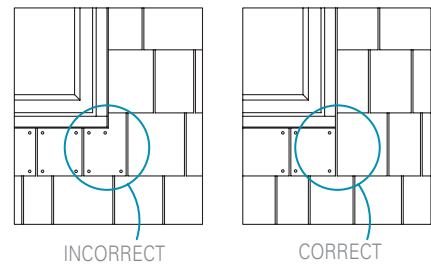

FIGURE 19

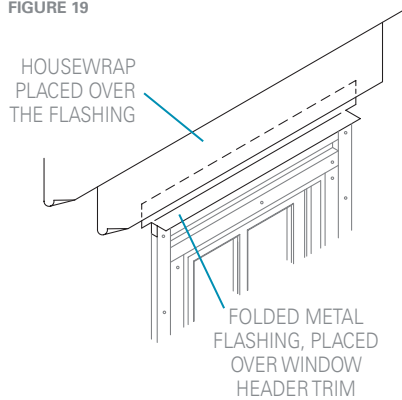

FIGURE 20

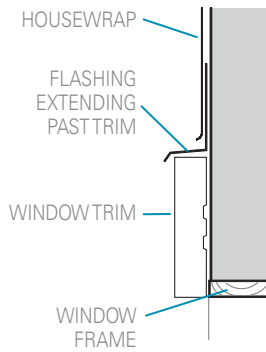
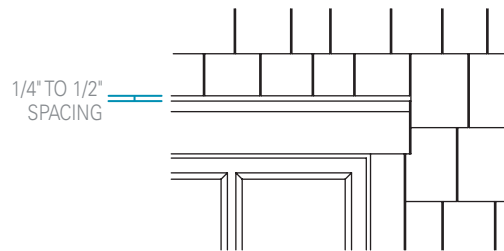

FIGURE 21



12. TOP OF THE WALL FINISH DETAILS

The typical way to finish the top of a wall is to install a trim and have the shingles butt directly to it. This is traditionally done when the shingle course is wide enough, a minimum 4" long shingle is the norm for this type of application. To facilitate airflow at the top of the wall, it is important to leave a 1/2" gap between the trim and the soffit.

FIGURE 22

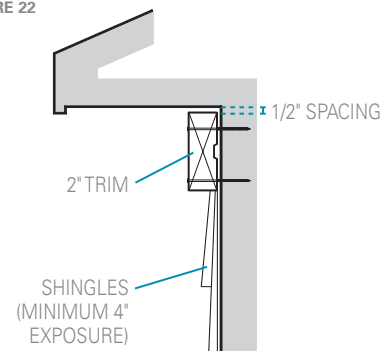

13. GABLES

Finishing under sloping soffits such as gables calls for special attention because the remaining triangular shingles have visible nails. These shingles are often narrower and more fragile. You must glue the back, cover with a trim and sometimes nail the lower corner for greater stability and to keep them from curling. There are several ways this can be done.

Cut the shingles at the end of the course on the same angle as the gable. This way the end shingles need fewer nails. [FIGURES 23 and 24]

OR Leave the section open at the end of the course. [FIGURE 25]

FIGURE 23

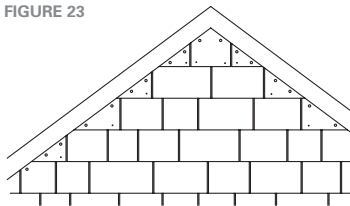

FIGURE 24

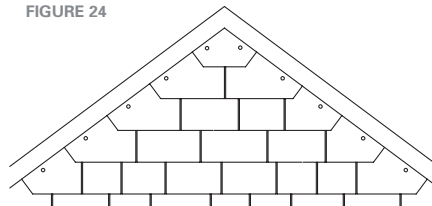
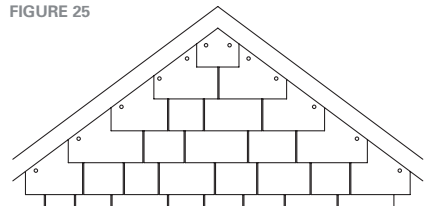

FIGURE 25



See the Maibec Wides Installation Guide at maibec.com/en/support.

14. DORMER/ROOF JUNCTION FINISH DETAILS

The shingle must be spaced at least 2" when it ends adjacent to the roof surface (or according to the building code). The spacing is necessary to properly drain water and prevent the build-up of ice against the shingles siding.

FIGURE 26

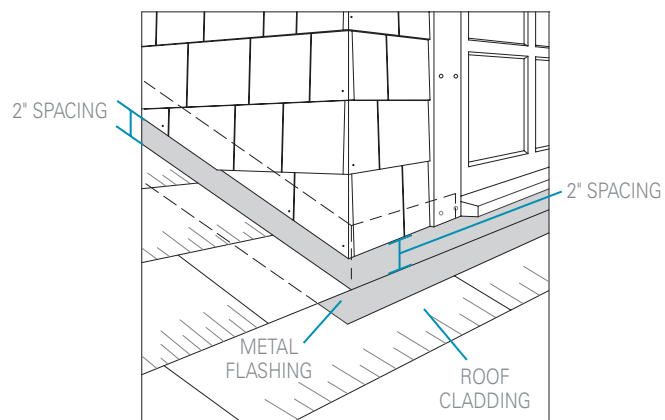

15. MAINTENANCE

As with all sidings, dirt build-up can occur; this can be due to a number of factors such as surrounding vegetation, dust or air pollution. Periodic cleaning may be required. Clean the dirt off of the siding using a gentle water spray from a household low-pressure garden hose (under 100 psi). In rare instances where the dirt is not removed with a simple spray of water, you can gently scrub the surface using a soft brush and a non-abrasive laundry detergent, or a dishwasher detergent diluted as

follows: 1/3 cup detergent for 3 litres of water. Because they produce suds, dish detergent are not recommended.

Rinse gently with a low-pressure garden hose (less than 100 psi). **Do not use a pressure washer.**

See the Maibec Sidings Maintenance Guide for more details at maibec.com/en/support/maintenance-program.

 Drawings not to scale.

IMPORTANT: COMPLIANCE WITH MAIBEC'S INSTALLATION, STORAGE AND MAINTENANCE REQUIREMENTS, AND WITH ALL APPLICABLE BUILDING CODES IS MANDATORY. PROBLEMS CAUSED BY FAILURE TO COMPLY WITH THESE REQUIREMENTS AND CODES MAY NOT BE COVERED BY THE APPLICABLE WARRANTIES.